

# CUTTING OUT LETTERS – Working With Symmetry

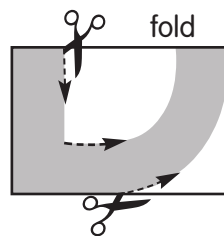

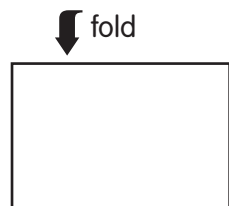

Used with permission of CrayolaTeachers.ca

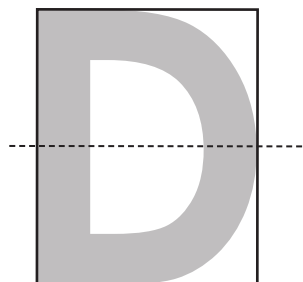
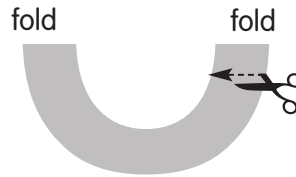
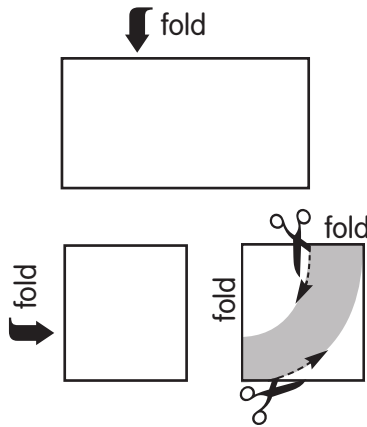
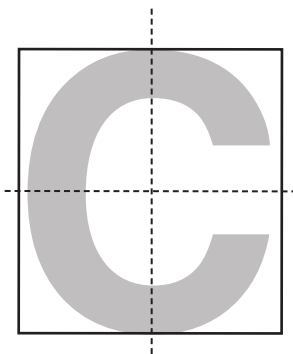
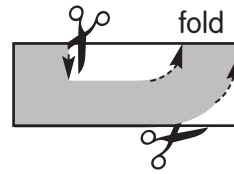
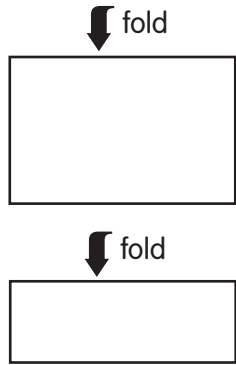
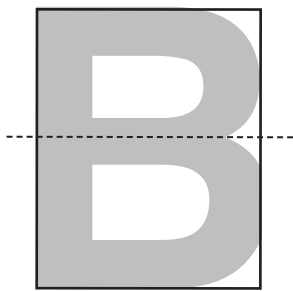
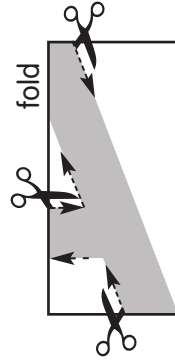
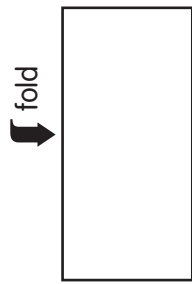
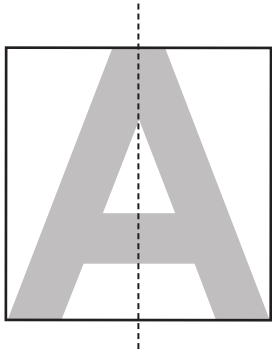
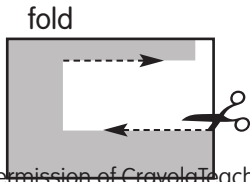
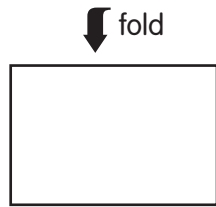
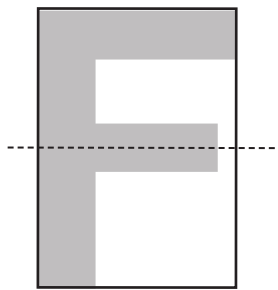
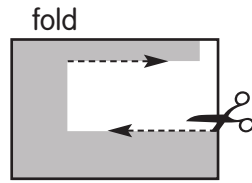
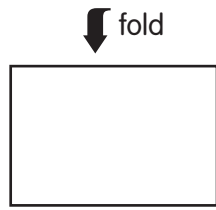
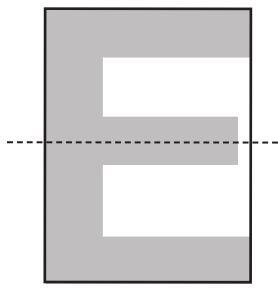
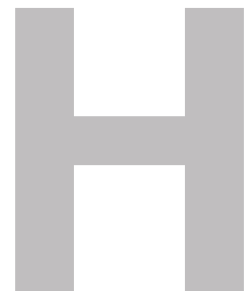
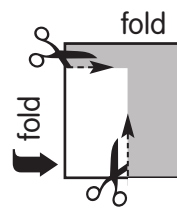
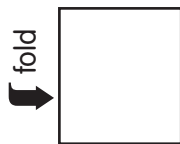
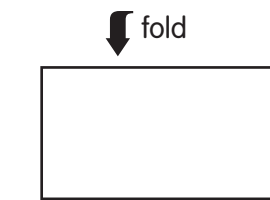
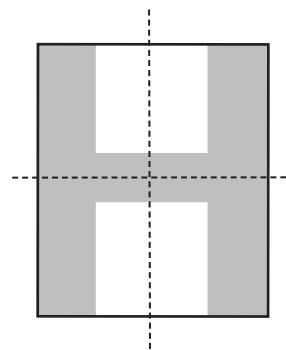
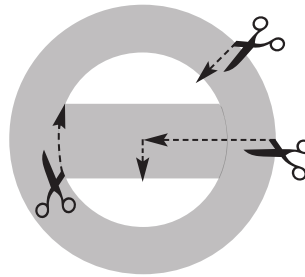
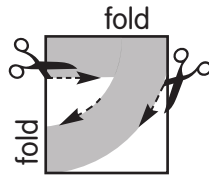
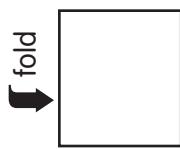
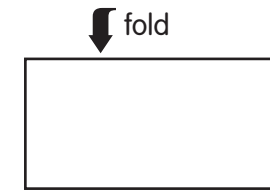
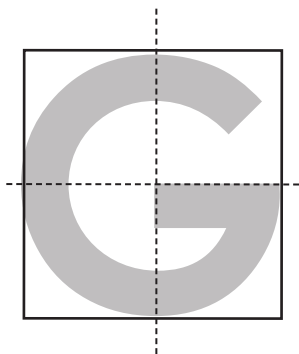

Used with permission of CrayolaTeachers.ca

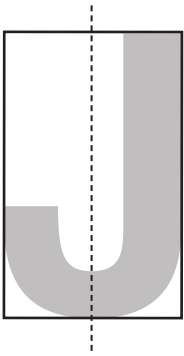
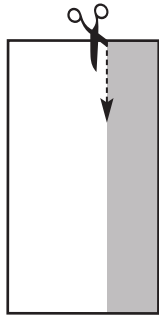
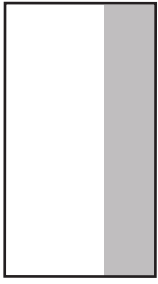

fold



fold

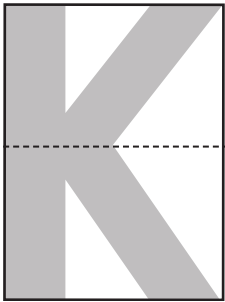
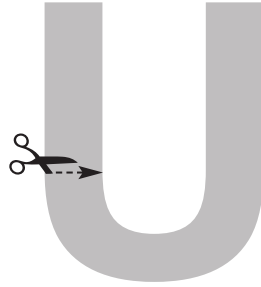

fold



fold

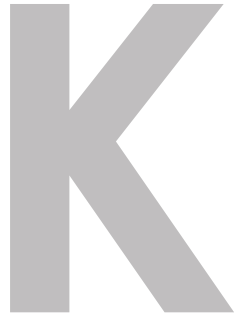
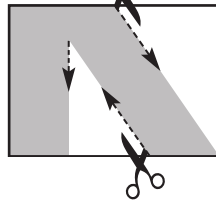

fold



fold

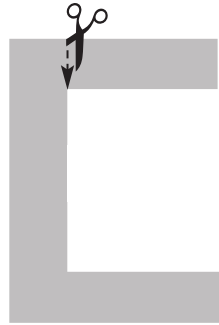
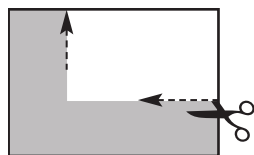

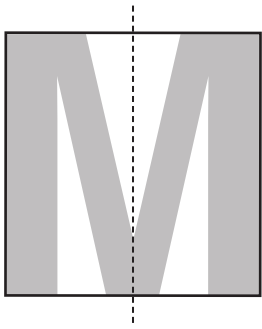

fold

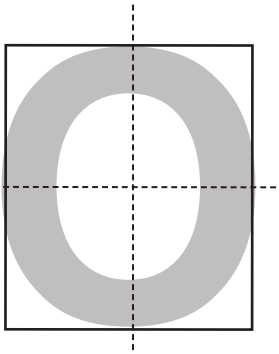
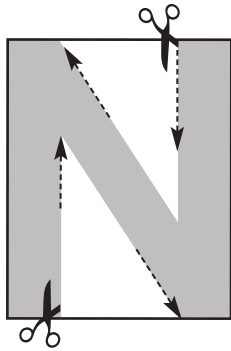
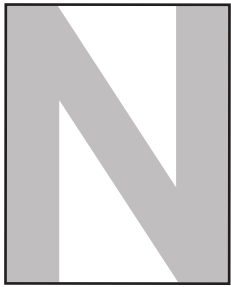
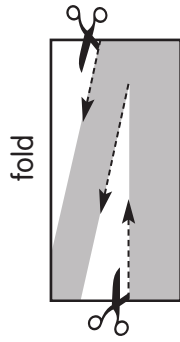

fold



fold

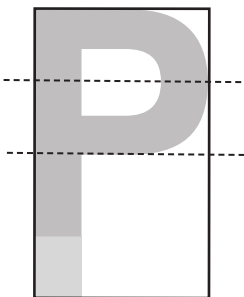
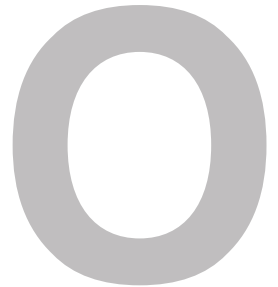
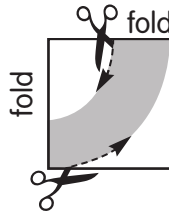
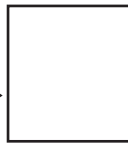

fold

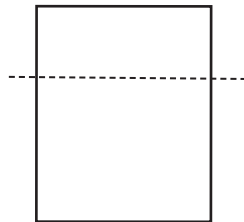

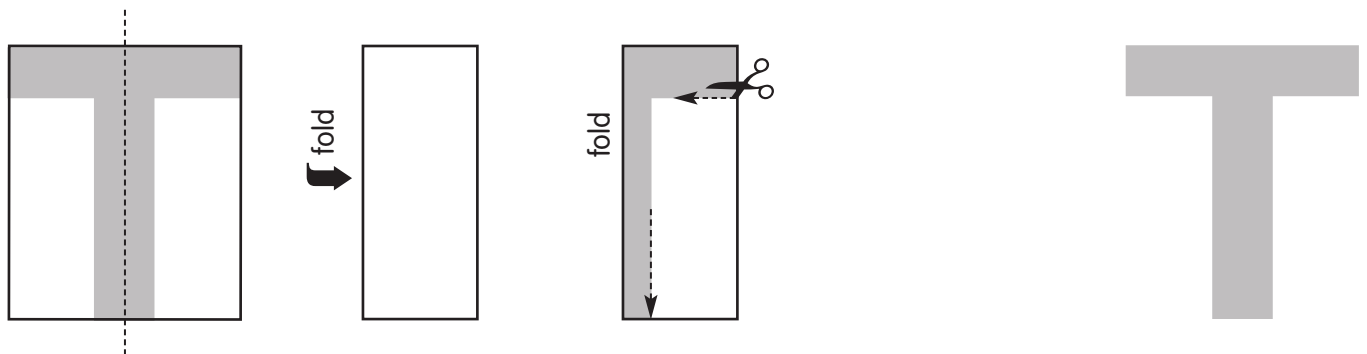
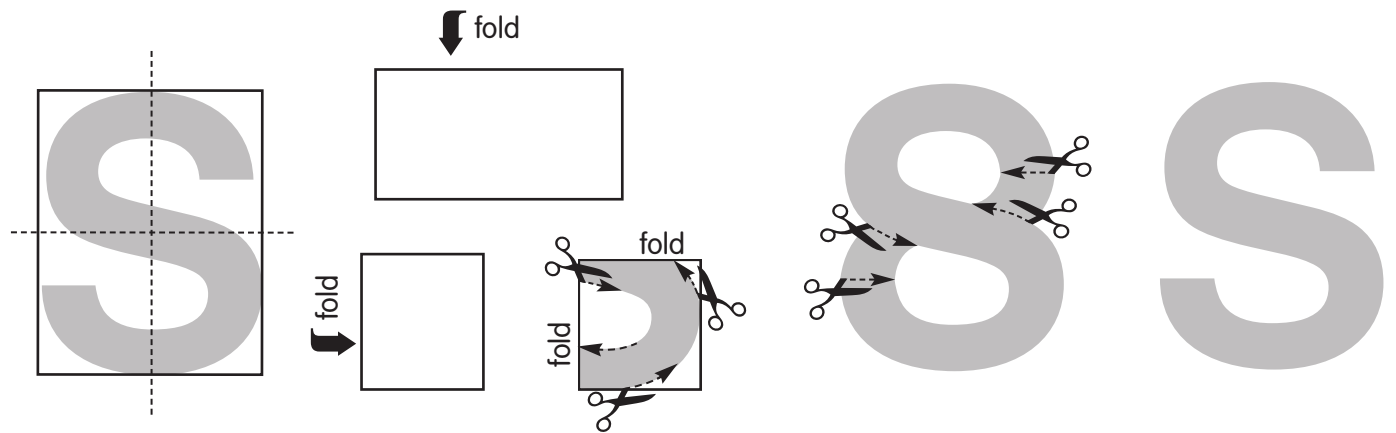
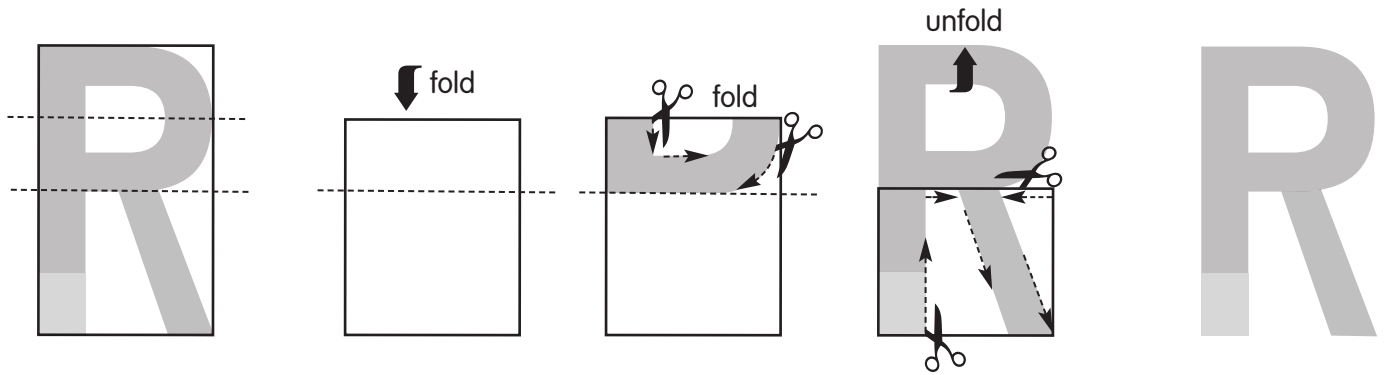
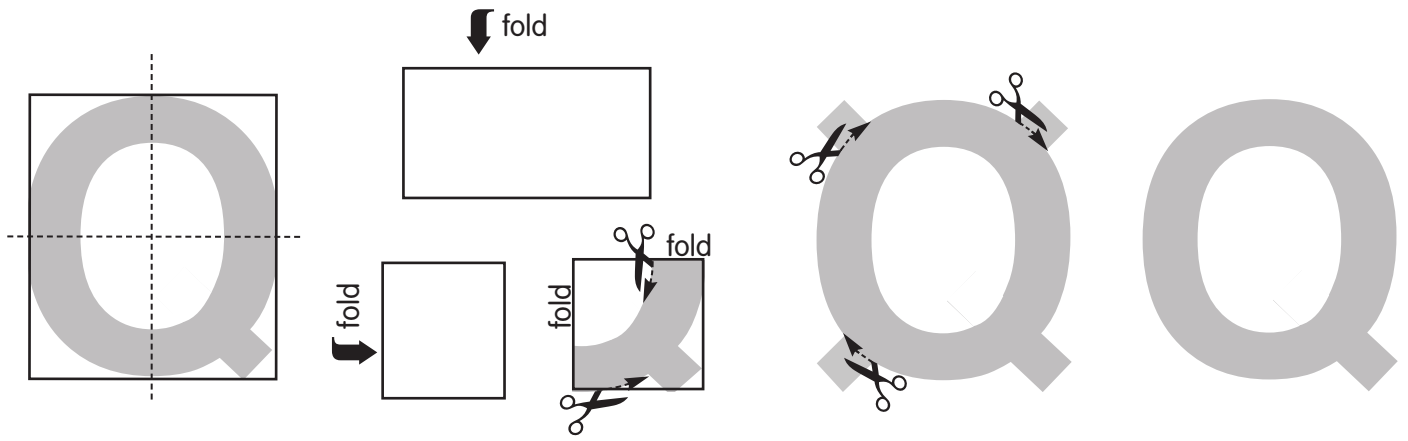

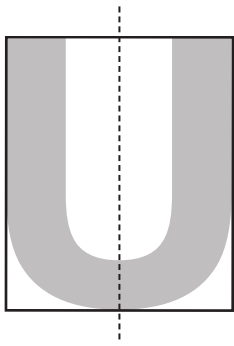

fold

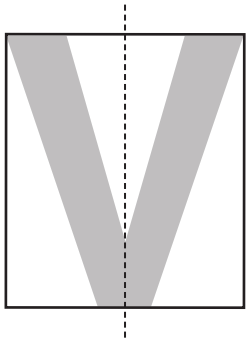
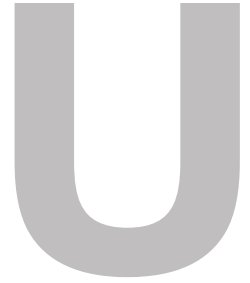
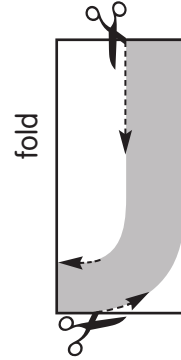

fold

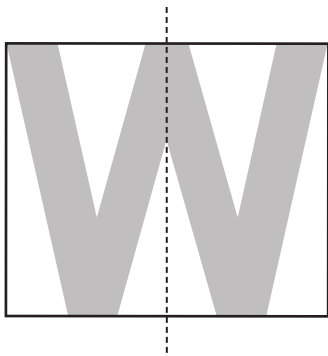
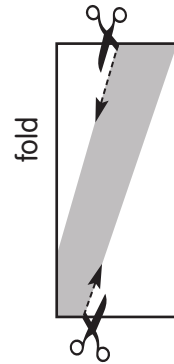

fold

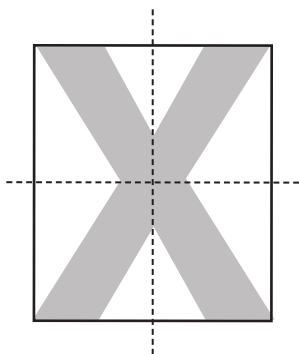
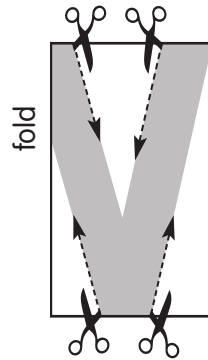

fold



fold

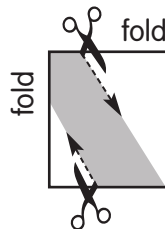

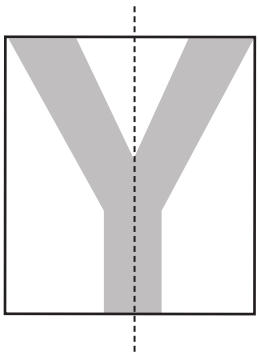

fold

